

16" HMWPE SPIGOT MOUNT (DIPS)

# FLAP VALVES

Fernco 16" (DIPS) Spigot Mount HMWPE Flap Valve provides passive backflow protection at stormwater outfalls and drainage discharge points. Designed to fit over the pipe OD, it allows water to exit freely while closing automatically under reverse flow conditions to help protect upstream systems from flooding and contamination. Lightweight, corrosion-resistant construction supports long-term performance in harsh outdoor environments.

- Spec-friendly sizing by pipe OD for a secure fit
- Lightweight HMWPE construction resists corrosion
- Passive, non-powered operation closes under reverse flow
- Integrated sealing surface helps reduce backflow leakage
- 316 Stainless steel hardware provides long-term outdoor performance

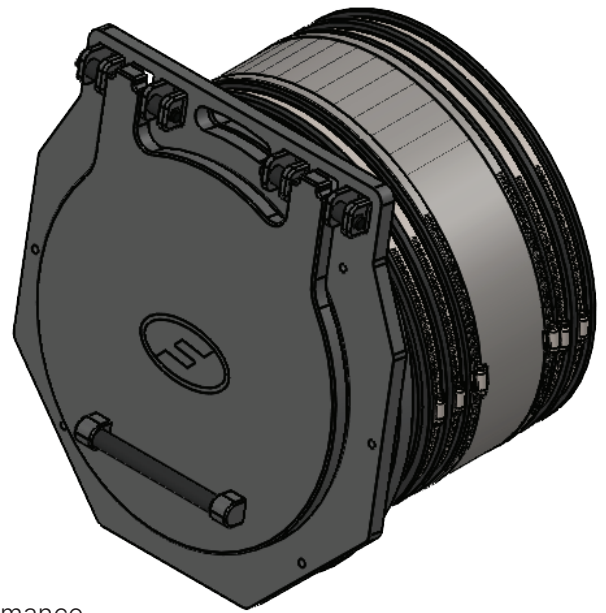

## Product Specifications

Product Number	FVS16-2
Description	Spigot Mounted Flap Valve (DIPS)
Size	16-inch
Materials	<ul style="list-style-type: none"> <li>• <b>Body/Backplate:</b> HMWPE</li> <li>• <b>Seal:</b> EPDM (BS EN 681-1:1996)</li> <li>• <b>Counterweight &amp; Hardware:</b> 316 SS</li> <li>• <b>Hinges and Other Components:</b> Glass-filled nylon (GFN)</li> </ul>
Part Weight	33.1 lbs

Standards	<p>Fernco Flap Valves exceed the leakage and performance requirements of:</p> <ul style="list-style-type: none"> <li>• DIN 19569-4</li> <li>• BS 7775:2005</li> <li>• Manufactured under an ISO 9001:2015 certified quality system.</li> </ul>
Recommended Max Temperature	<p>Constant 120°F Intermittent 180°F</p>
Country of Origin	United Kingdom (UK)
Note	<ul style="list-style-type: none"> <li>• For gravity drainage applications only</li> <li>• Working pressure of 10.75 PSI</li> <li>• Cracking head 0.4 PSI</li> <li>• Coupling Sold Separately</li> </ul>

