

## 16" HMWPE WALL MOUNT

# FLAP VALVES

Fernco 16" Wall Mount HMWPE Flap Valve provides passive backflow protection at stormwater outfalls and drainage discharge points. Designed to fasten to a flat wall or headwall surface, it allows water to exit freely while closing automatically under reverse flow conditions to help protect upstream systems from flooding and contamination. Lightweight, corrosion-resistant construction supports long-term performance in harsh outdoor environments.

- Co-extruded sealing interface eliminates added tapes or sealants
- HMWPE body provides corrosion resistance with lightweight handling
- Passive, non-powered operation closes under reverse flow
- Integrated sealing surface helps reduce backflow leakage
- 316 Stainless steel hardware provides long-term outdoor performance

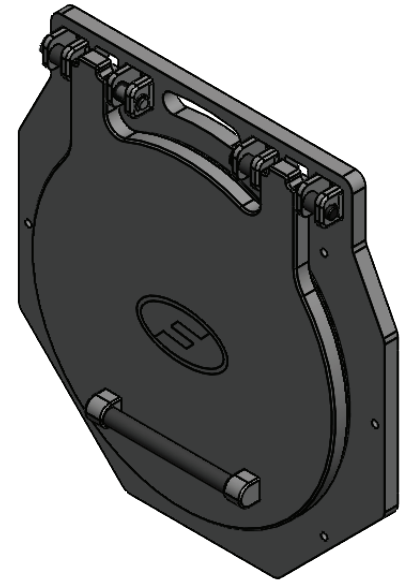

## Product Specifications

Product Number	FV16
Description	Wall Mounted Flap Valve
Size	16-inch
Materials	<ul style="list-style-type: none"> <li>• <b>Body/Backplate:</b> HMWPE</li> <li>• <b>Seal:</b> EPDM (BS EN 681-1:1996)</li> <li>• <b>Counterweight &amp; Hardware:</b> 316 SS</li> <li>• <b>Hinges and Other Components:</b> Glass-filled nylon (GFN)</li> </ul>
Part Weight	17.6 lbs

Standards	Fernco Flap Valves exceed the leakage and performance requirements of: <ul style="list-style-type: none"> <li>• DIN 19569-4</li> <li>• BS 7775:2005</li> <li>• Manufactured under an ISO 9001:2015 certified quality system.</li> </ul>
Recommended Max Temperature	Constant 120°F Intermittent 180°F
Country of Origin	United Kingdom (UK)
Note	<ul style="list-style-type: none"> <li>• For gravity drainage applications only</li> <li>• Working pressure of 10.75 PSI</li> <li>• Cracking head 0.4 PSI</li> <li>• FVMS-03-US wall mounting kit, sold separately</li> </ul>

