

10" HMWPE WALL MOUNT

FLAP VALVES

Fernco 10" Wall Mount HMWPE Flap Valve provides passive backflow protection at stormwater outfalls and drainage discharge points. Designed to fasten to a flat wall or headwall surface, it allows water to exit freely while closing automatically under reverse flow conditions to help protect upstream systems from flooding and contamination. Lightweight, corrosion-resistant construction supports long-term performance in harsh outdoor environments.

- Co-extruded sealing interface eliminates added tapes or sealants
- HMWPE body provides corrosion resistance with lightweight handling
- Passive, non-powered operation closes under reverse flow
- Integrated sealing surface helps reduce backflow leakage
- 316 Stainless steel hardware provides long-term outdoor performance

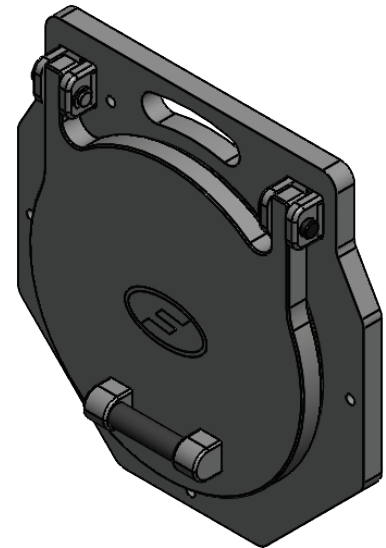

Product Specifications

Product Number	FV10
Description	Wall Mounted Flap Valve
Size	10-inch
Materials	<ul style="list-style-type: none"> • Body/Backplate: HMWPE • Seal: EPDM (BS EN 681-1:1996) • Counterweight & Hardware: 316 SS • Hinges and Other Components: Glass-filled nylon (GFN)
Part Weight	7.9 lbs

Standards	Fernco Flap Valves exceed the leakage and performance requirements of: <ul style="list-style-type: none"> • DIN 19569-4 • BS 7775:2005 • Manufactured under an ISO 9001:2015 certified quality system.
Recommended Max Temperature	Constant 120°F Intermittent 180°F
Country of Origin	United Kingdom (UK)
Note	<ul style="list-style-type: none"> • For gravity drainage applications only • Working pressure of 10.75 PSI • Cracking head 0.4 PSI • FVMS-02-US wall mounting kit, sold separately

